

# *Renaissance*

SLIDING DOORS

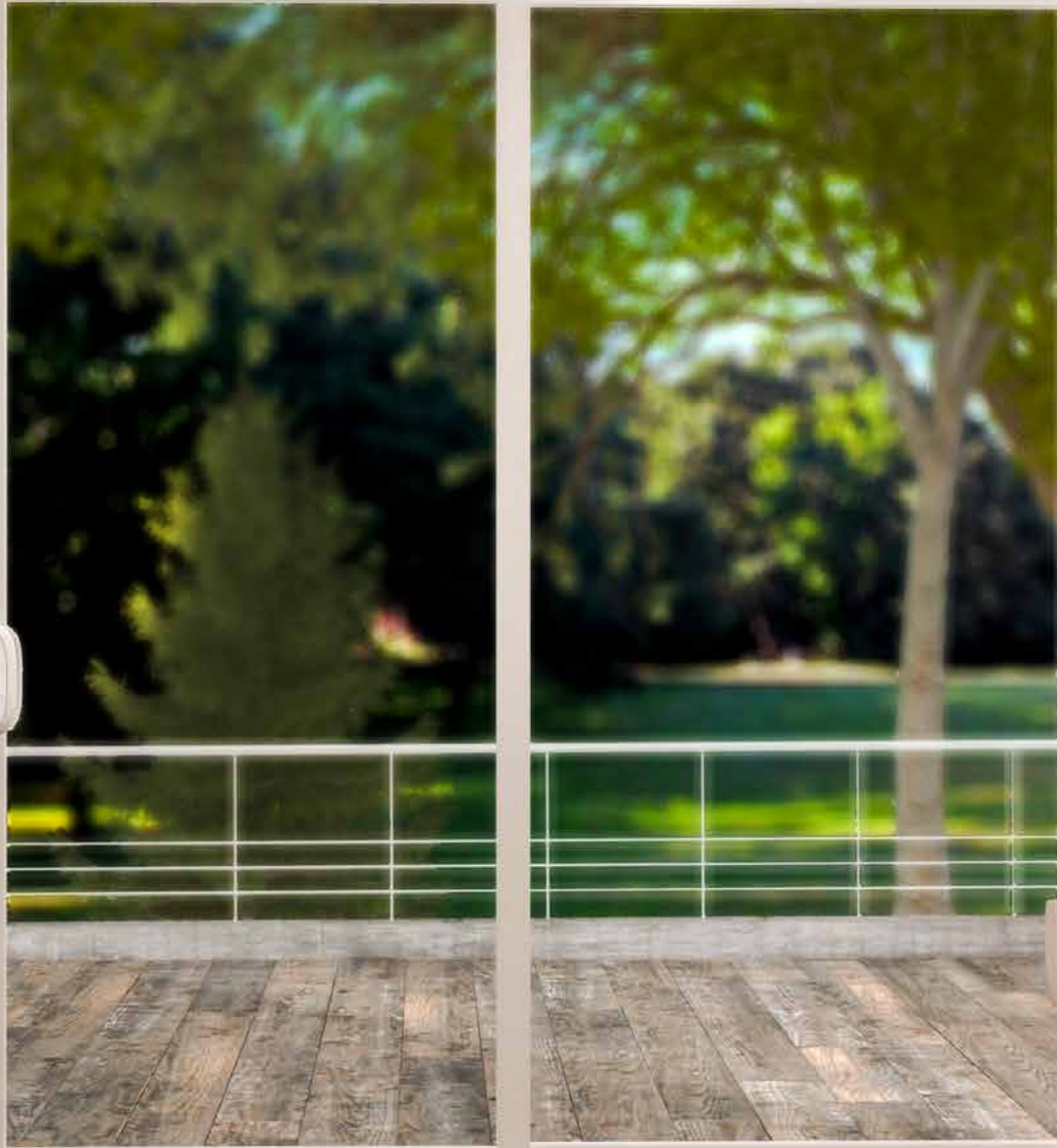

**STANDARD**  
DOORS

[www.StandardDoors.com](http://www.StandardDoors.com)



## FEATURES:

- › Low-E double glazed insulated glass with argon gas and non-metallic warm edge spacer
- › Exclusive Level 40 lock with interior and exterior ergonomic handles
- › Exclusive tandem ball bearing rolling system
- › Heavy duty aluminum extruded and powder coated non-skip gliding screen
- › Structural primed wood frame
- › Exterior and interior PVC clad frame
- › One piece PVC sill with integral interior cladding
- › Weather protection with 100% high-fin weather seals and tri-seal jambs
- › Mechanically assembled weather-proof PVC panels
- › Hidden top track (PVC clad)
- › Extruded PVC colours (Blue White 141, Cream White 137)

## OPTIONS:

- › One-point or two-point mortise locking handles
- › Key lock
- › Two position foot lock
- › Security bar
- › V-Groove Glass
- › Bronze or grey tinted glass
- › Laminated glass
- › Internal grills - Rectangular, georgian and slimline grills
- › Simulated divided lites
- › Garden panels (smooth or embossed)
- › Interior frame extension (max. 13 ¼")
- › PVC brickmould
- › PVC capped wood brickmould 1½" & 2"
- › Aluminum brickmould
- › Anodized aluminum sill extension
- › Extruded clear anodized aluminum sill cladding
- › Nailing fin
- › Sidelites, toplites, and shaped toplites
- › Painted doors and simulated woodgrain painted finish
- › Custom colours, sizes and frame depths also available.

## INSIDE YOUR DOOR:

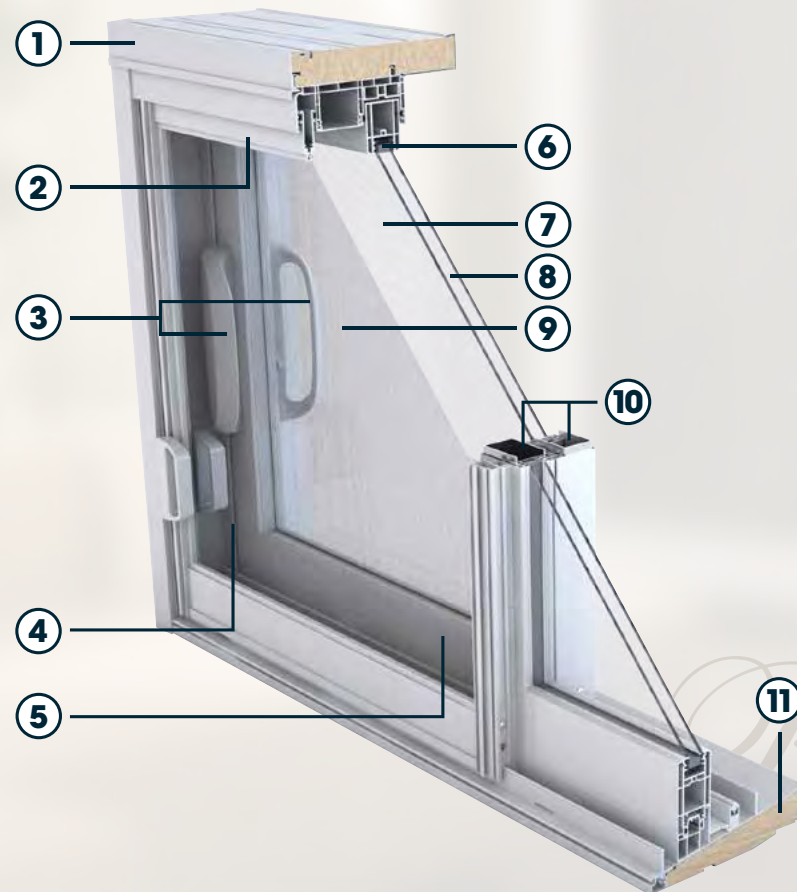

1. PVC wipe-clean finish is virtually maintenance free
2. Sturdy extruded powder coated aluminum screen frame
3. Ergonomic handles (interior & exterior)
4. High-fin weatherseal prevents heat loss and air infiltration
5. Tandem sealed ball bearing rollers
6. Warm edge spacer
7. Low-E
8. Argon Gas
9. Fiberglass screen mesh does not dent
10. Galvanized steel reinforcing
11. PVC clad (interior & exterior) primed wood frame

*Renaissance*  
SLIDING DOORS











*Let the light shine in with a quadruple center opener.*

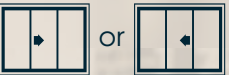

## SIZING CHART:

CONFIG	WIDTHS		HEIGHTS			
	mm	inches	71 3/8"	79 3/16"	81 3/16"	95 3/8"
XO/OX	1486	58 1/2"		✓	✓	
	1508	59 3/8"	✓	✓	✓	✓
	1788	70 3/8"	✓	✓	✓	✓
	2118	83 3/8"		✓	✓	
	2394	94 1/4"		✓	✓	✓
XOX/XOO/OOX	2227	87 11/16"	✓	✓	✓	✓
	2646	104 3/16"	✓	✓	✓	✓
	3142	123 11/16"		✓	✓	
	3556	140"		✓	✓	✓
OXO	2264	89 1/8"	✓	✓	✓	✓
	2683	105 5/8"	✓	✓	✓	✓
	3178	125 1/8"		✓	✓	
	3594	141 1/16"		✓	✓	✓
OXXO	2951	116 3/16"	✓	✓	✓	✓
	3510	138 3/16"	✓	✓	✓	✓

Available depths: 140mm (5 1/2"), 168mm (6 5/8"), 184mm (7 1/4")

## PERFORMANCE:

Certified according to: AAMA/WDMA/CSA101/I.S.2/A440-08 and A440S1-09.

Please see our website for performance information at:  
<http://www.standarddoors.com/renaissance>





## GRILLS



Rectangular

Georgian

Slimline

SDL

### Colour Options

#### RECTANGULAR, GEORGIAN & SDL

Can be painted to match the colour of your door, see dealer for paint chart

#### SLIMLINE COLOURS

White

Pewter

Brass



Standard Grills

Border Grills

Valencia Grills

7/8" SDL

## LOW-E GLASS w/ ARGON GAS

WARMER IN THE WINTER

COOLER IN THE SUMMER

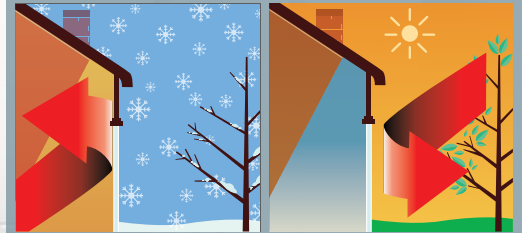

Please check if your door configuration is Energy Star certified for your region at [www.nrcan.gc.ca](http://www.nrcan.gc.ca)

## HARDWARE OPTIONS

### Exclusive Handle

One of the safest in North America!



Exclusive Handle (interior)

Key lock handle available

### Mortise Handles

Euro

Contemporary



White

Satin nickel

Oil rubbed bronze

Brushed chrome

Brass

White

Satin nickel

Oil rubbed bronze

All handles available with or without keylock.

## ABOUT STANDARD

Founded in 1974, Standard Doors is a leading family owned Canadian door manufacturer. At Standard, our core value is innovation. That's why we have our research and development team constantly working on developing exciting new features and options for our clients.

Standard Doors is devoted to providing cutting-edge design, superior quality products with the highest levels of energy efficiency, security, and performance ratings in every category.

With a Standard Door in your home, you'll enjoy exceptional comfort and security.

## CONTACT

Standard Doors Inc.  
2300 Francis-Hughes Ave.  
Laval, QC H7S 2C1

Toll-Free: 1-800-361-7535  
[info@StandardDoors.com](mailto:info@StandardDoors.com)  
[www.StandardDoors.com](http://www.StandardDoors.com)

## GUARANTEE

20 years against insulated glass seal failure  
20 years on PVC  
10 years on parts  
10 years against spontaneous glass breakage (interior glass only)

Please note that our guarantees are transferable.



fenestration  
canada

