



GreenView
WINDOWS & DOORS

BY KP BUILDING PRODUCTS

Beautifully energy-efficient windows.



greenviewwindows.com

Designed to enhance.
Crafted to last.
Engineered to perform.
Guaranteed for life.





L I F E T I M E W A R R A N T Y

We take great pride in our craftsmanship and manufacturing processes, and we offer the best warranty in the industry to back it up. The GreenView Lifetime Warranty covers all components including insulated glass, frames, sash and hardware.

Our unique, no questions asked warranty is fully transferable at no additional charge.

Learn more about the full GreenView for life warranty, visit us on the web at www.greenviewwindows.com



L I F E T I M E C O V E R A G E O N A C C I D E N T A L G L A S S B R E A K A G E .



L I F E T I M E C O V E R A G E O N A L L H A R D W A R E .



L I F E T I M E C O V E R A G E O N S E A L F A I L U R E .



L I F E T I M E C O V E R A G E O N F R A M E V I N Y L & V I N Y L S A S H C O M P O N E N T S .



F U L L Y T R A N S F E R A B L E A T N O E X T R A C H A R G E .



N O N - P R O R A T E D , F U L L L I F E T I M E C O V E R A G E .



Clearly beautiful.
Remarkably energy-efficient.



vertex3

HIGH-PERFORMANCE WINDOW TECHNOLOGY

GreenView proprietary **vertex3** high-performance glass technology is engineered to provide remarkable thermal efficiency, crystalline glass clarity and superior air infiltration protection.

Thermal efficiency **29%**

OUTPERFORMS INDUSTRY STANDARDS BY UP TO

ēvolv

Proprietary **ēvolv** Glass Technology provides triple-pane thermal efficiency in a double-pane window by reflecting escaping UV rays back into the room, increasing thermal efficiency by up to 29% above industry average,* which adds up to substantial energy savings.

*Average measured from Energy Star® data of three other window manufacturers.

Glass clarity **99%**

REDUCES WATER SPOTS BY UP TO

EC TECH

Patented **EC TECH** Technology produces cleaner, clearer windows. The titanium dioxide coating absorbs the sun's UV rays, loosening dirt particles and allowing water to rinse them away naturally. Water spots are reduced by 99%, creating crystalline glass clarity.

Air infiltration protection **24%**

CUTS DRAFTS BY UP TO



Industry-leading **Owens Corning®** Air Sealing Technology offers unmatched air infiltration protection, cutting drafts by up to 24%** with a mold resistant seal and guaranteed for life.

**Based on independent laboratory testing.

THE PINK PANTHER™ & © 1964-2017 MGM. © 2017 Owens Corning. All Rights Reserved.

Cutting-edge features.

Every GreenView window lets you capture your style, bring the light in and keep the elements out. That's simply what we do. All of our windows are made with care and dedication to excellence. You will always get the best window we can make because you deserve nothing less.

ENERGY STAR®

GreenView Windows meet or exceed Energy Star® most severe standards. For more details on our energy performance data, please visit us online at: greenviewwindows.com

INTERCEPT® ULTRA WARM-EDGE SPACER SYSTEM

The best combination of durability, rigidity and thermal performance, resulting in longer-lasting and more energy-efficient windows

ēvolv

Double-pane glass with triple-pane performance. Significantly exceeds Energy Star® standards to reduce energy costs.

EC TECH

Patented **EC TECH** Technology reduces water spots by 99%, creating a crystalline glass clarity

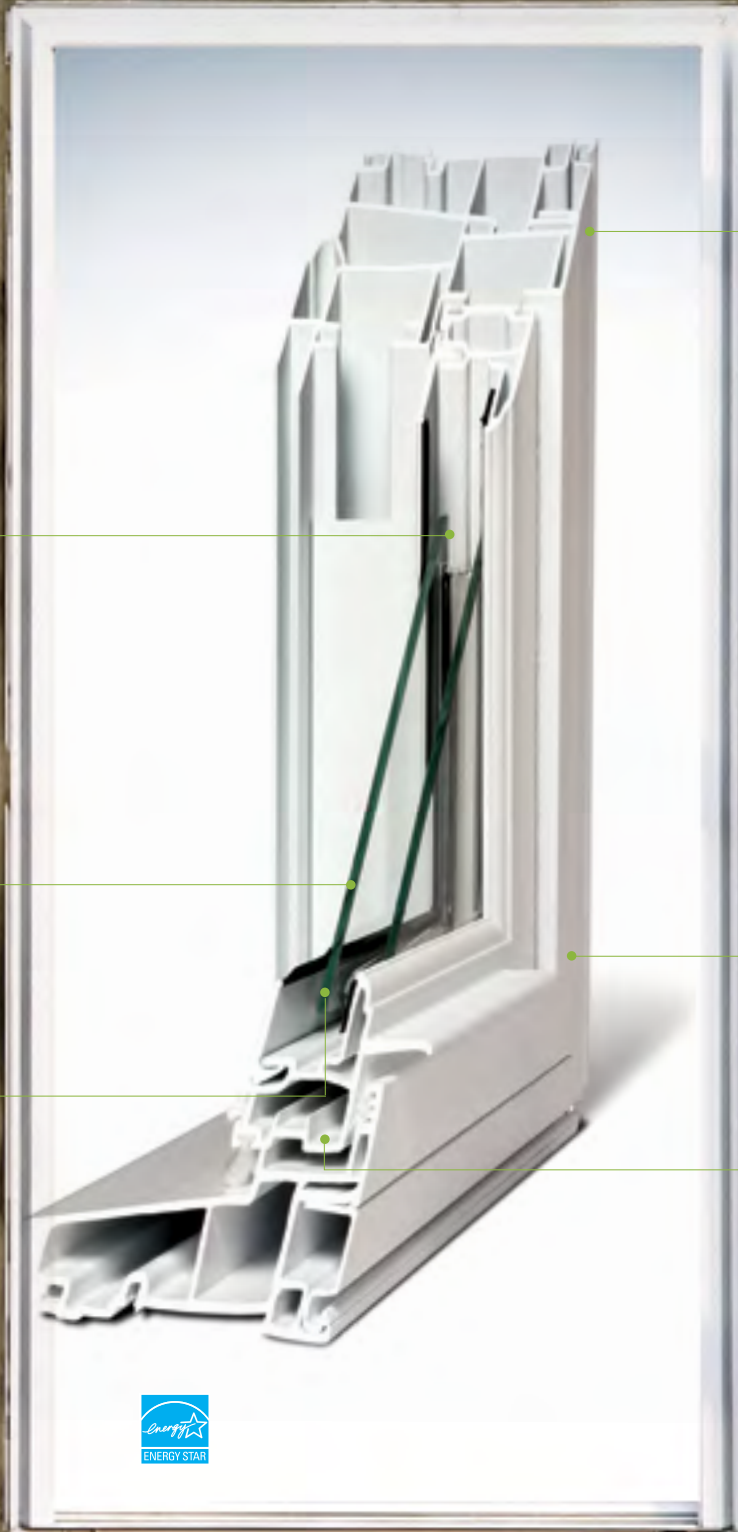

PREMIUM RAW MATERIALS

Vinyl color is formulated throughout to ensure that the lustrous finish will never chip, peel, crack or warp

CONSTANT FORCE BALANCE SYSTEM

For smooth and easy operation (hung windows)

TRUTH™ ENCORE FOLDING HANDLE

Won't interfere with your window covering and requires 33% less effort to operate (casement & awning windows)

FULLY WELDED SASH & FRAME

Fully welded sash and frame for a stronger and more durable window

OWENS CORNING® AIR SEALING TECHNOLOGY

Reduces the risk of air or water infiltration and provides a mold resistant seal



Bring light into your world.

GreenView Windows add space and light to any room.
Available in a variety of designs and configurations so you can create your own beautiful opening.



SINGLE & DOUBLE-HUNG

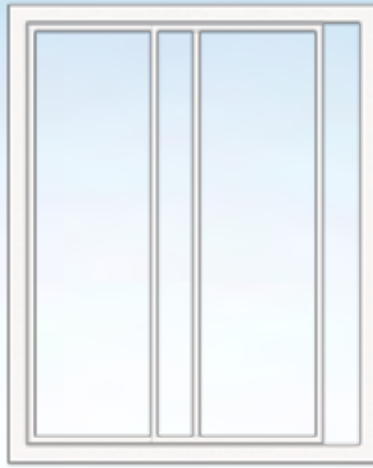

SLIDER



CASEMENT



ARCHITECTURAL
FIXED CASEMENT



AWNING



BAY & BOW

Options & Hardware

Greenview offers a wide range of options to customize your windows. Think of the possibilities! Our windows are available with a selection of features, all designed to bring out the beauty of your home.

INTERIOR GRILLES & SIMULATED DIVIDERS

*Available in colored finishes.



GEORGIAN*



FLAT BAR*



BRASS



PEWTER



7/8" SDL



2" SDL

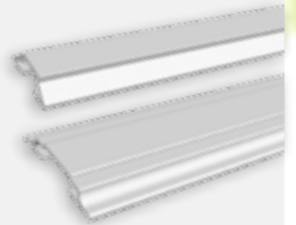

2" available for casement/awning only.
7/8" available
Available in colored finishes.

INTERIOR FINISH OPTIONS



VINYL CLAD PINE



NATURAL OAK



NATURAL PINE



PRIMED PINE



PVC

EXTERIOR FINISH OPTIONS

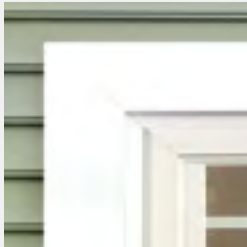

3-1/2" FLAT TRIM
AVAILABLE WITH 1" SILL



2" BRICKMOULD
AVAILABLE WITH 1" SILL



1-1/4" BRICKMOULD
AVAILABLE WITH 1" SILL

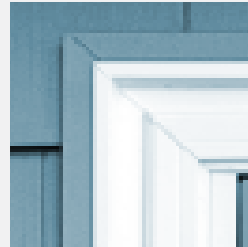

3/4" BRICKMOULD



1-1/16" EXTENSION &
2 5/8" EXTENSION

CASEMENT WINDOW CRANK HANDLE COLORS*



STANDARD WHITE



PEWTER



BRASS



BRUSHED NICKEL

AlumHybrid Specialty Windows.



The strength & beauty of aluminum combined with the energy efficiency of vinyl.

Our state-of-the-art AlumHybrid window features an exterior frame made of extruded aluminum joined to an interior frame made of rigid PVC. AlumHybrid delivers the strength and beauty of aluminum and the energy efficiency of vinyl. It is simply the best of both worlds without any compromise.



Features

- Extruded aluminum exterior joined to the PVC interior structure.
- Extruded aluminum goes up to the centre of the 4-9/16" frame and tucks into the PVC frame to increase air and water tightness.
- PVC sash surrounds the glass for better air and water tightness.
- Available in Casement, Awning, Fixed Picture Bay & Bow models.

Colors

White	Ivory 08	Matchcoat Beige 75	Khaki 96	Chocolate 28	Commercial Brown 12	Hunter Green
Metallic Silver*	Metallic Pewter*	Cactus 77	Charcoal 49	Metallic Gray* 19	Metallic Graphite*	Rustic Granite 55
Black 15						

*Premium Colors
• Due to the limitations of the printing process, colors above may not be accurate. Ask to see the official color chart for accurate matches.

Exterior profiles

GreenView provides a range of exterior options and capabilities to make your windows a beautiful feature of your home.

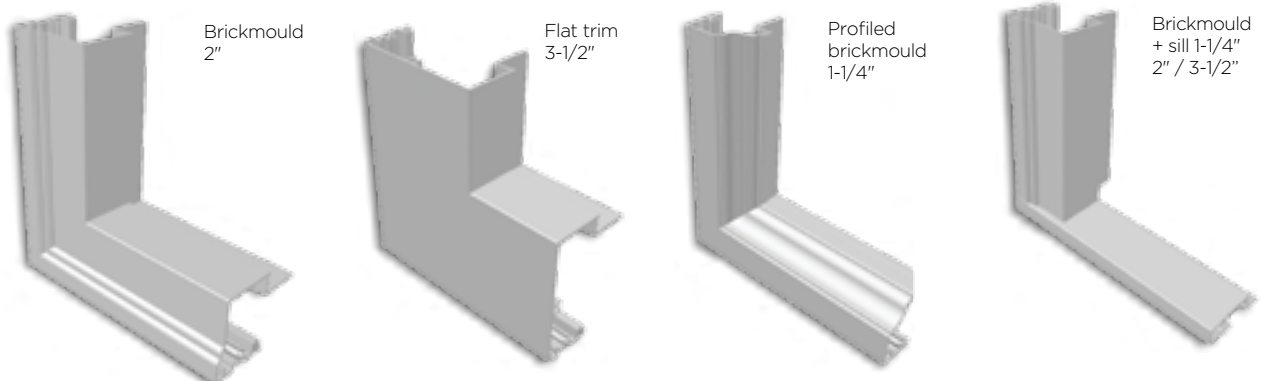

Color Options

(PVC Windows & Patio Doors)



Using our state of the art paint process:



Chroma VX technology is based on a specific blend of urethane and acrylic polymers. This proprietary process provides a beautiful rich, low gloss, smooth finish that will last throughout the years.

Chroma VX, an exclusive technologically advanced formulation enhances weatherability and is compliant with the highest standards of AAMA.

Our versatile color system allows you to add any of our window colors (below) to your window's exterior, while leaving the interior finish a neutral white.

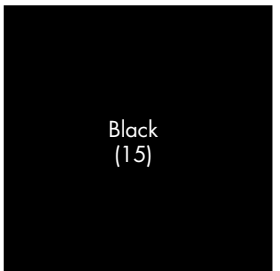
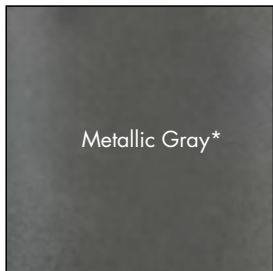
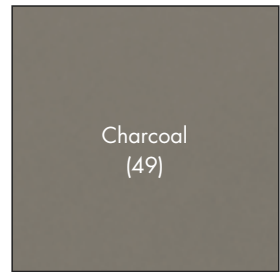
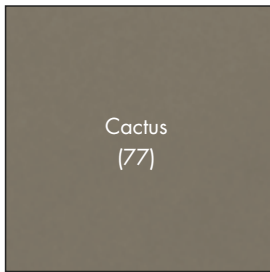
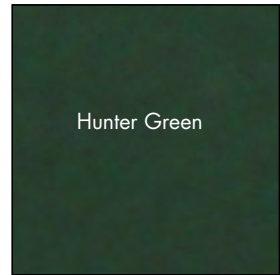
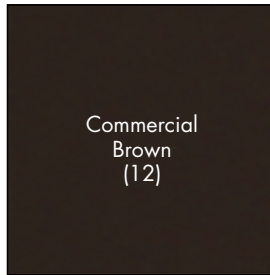
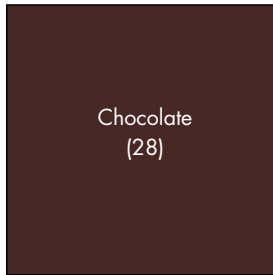
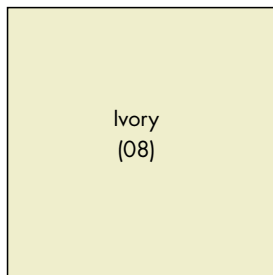

* Premium Colors

* Due to the limitations of the printing process, colors above may not be accurate. Ask to see the official color chart for accurate matches.

Rich Woodgrain Interior Options

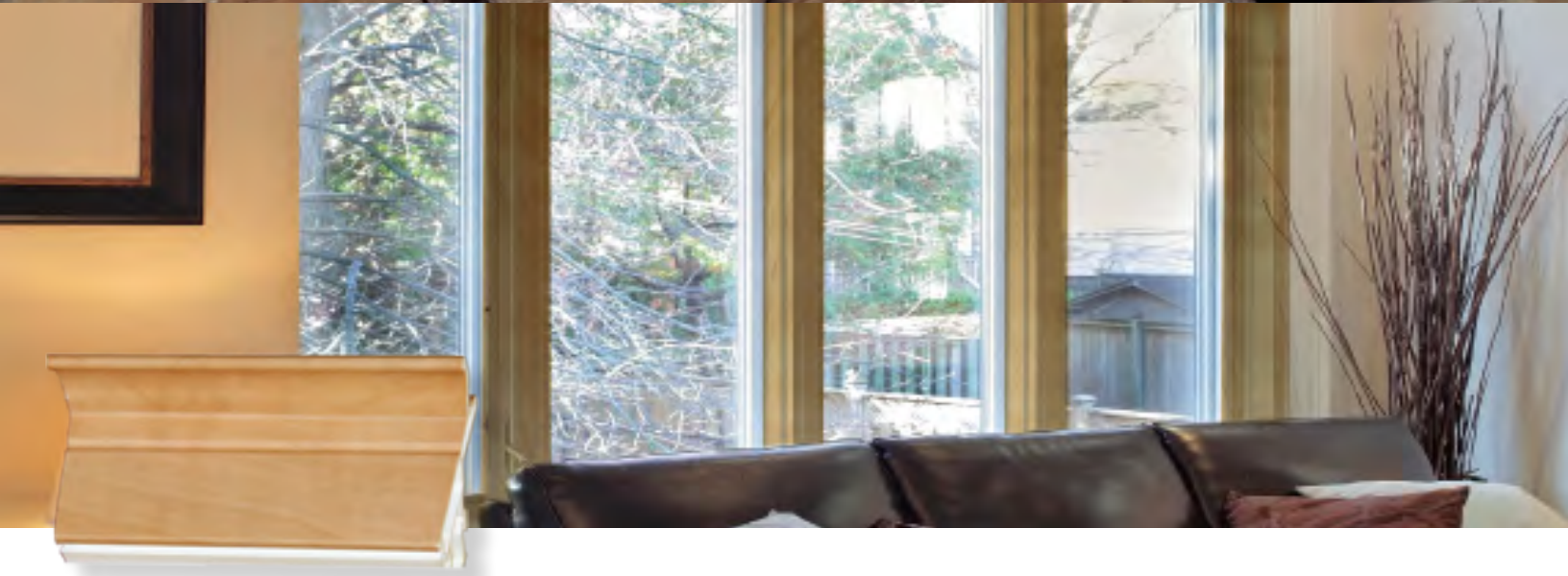

The woodgrain color palette of our interior window frames will give warmth and depth to any room. The elegant woodgrain finish can enhance the view and draw the eye outside. Their superior functionality and versatility, along with their elegant look and classic hues, will inspire unique design options to complement any home.

MEDIUM MAPLE



NATURAL OAK



DARK OAK

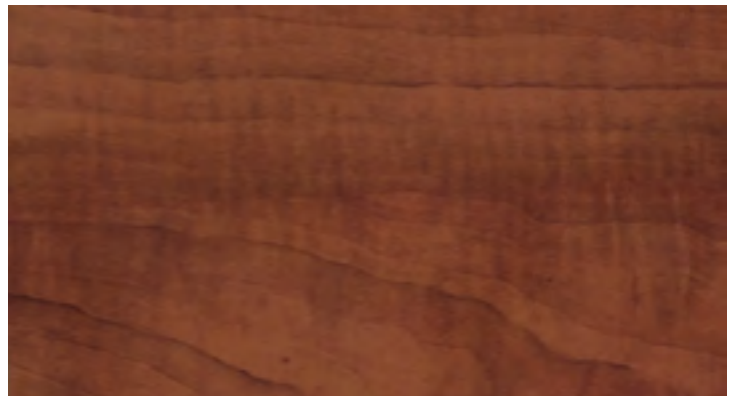

NATURAL CHERRY



greenviewwindows.com



U.S.A.

© 2017 KP Building Products. All Rights Reserved.
All Trademarks are owned by KP products
KP_GR_BRO-US2017